



The software programs described in this document and the information contained in this document are confidential and proprietary products of KISTERS or its licensors. KISTERS waives copyright for licensed software users to print out parts of the documentation in hard copy for their own use only. This documentation may not be transferred, disclosed, or otherwise provided to third parties. In duplicating any part of this document, the recipient agrees to make every reasonable effort to prevent the unauthorized use and distribution of the proprietary information.

No parts of this work may be reproduced in any form or by any means - graphic, electronic, or mechanical, including photocopying, recording, taping, or information storage and retrieval systems - without the written permission of the publisher.

KISTERS reserves the right to make changes in specifications and other information contained in this publication without prior notice.

KISTERS makes no warranty of any kind with regard to this material including, but not limited to, the implied warranties or merchantability and fitness for a particular purpose.

KISTERS shall not be liable for any incidental, indirect, special or consequential damages whatsoever (including but not limited to lost profits) arising out of or related to this documentation, the information contained in it or from the use of programs and source code that may accompany it, even if KISTERS has been advised of the possibility of such damages.

Any errors found in any KISTERS product should be reported to KISTERS where every effort will be made to quickly resolve the problem.

Products that are referred to in this document may be either trademarks and/or registered trademarks of the respective owners. The publisher and the author make no claim to these trademarks.

Copyright 2024 KISTERS
Internet: viewer.kisters.de
E-mail: support-viewer@kisters.de
Phone: +49 (0) 2408 9385-360

Author: KISTERS
Date of print of current edition: 14.02.2024
Current software version: 2020.1

The logo for KISTERS, featuring a stylized 'K' symbol followed by the word 'KISTERS' in a bold, sans-serif font.

Table of Contents

Part I	Basic Operation	4
1.1	Registration procedure	5
1.2	Login to VisShare	6
1.3	User Interface	6
1.3.1	VisShare Start Page	6
1.3.2	File Manager	11
Part II	Tutorial	16
2.1	'Projects' Section	17
2.1.1	Create a Project	17
2.1.2	Upload File or Assembly	19
2.1.3	Organize Projects	20
2.1.4	Manage Projects	21
2.2	'Private' Section	25
2.2.1	Create a Folder	25
2.2.2	Upload File or Assembly	26
2.3	General Interaction with Files and Folders	26
2.4	Interaction with CAD/CAM Files	29
2.4.1	Preview of CAD/CAM Files	29
2.4.2	Save File in 3DVS Format	29
2.4.3	Compare two 3D Models with Each Other	30
2.4.4	Open File in Scene	31
2.4.5	Import File into Scene	32
2.5	File Sharing	33
2.5.1	Share Files with Users	33
2.5.2	Share Files via a Link	34
Part III	Tutorial 3DViewStation WebViewer	0



Chapter I:

Basic Operation



1 Basic Operation

This chapter explains the basic operation of VisShare.

- [Registration](#) 
- [Login](#) 
- [User Interface](#) 

1.1 Registration procedure

In order to log in to the web portal of VisShare you have to register first.

- Open your browser and go to the URL <https://webviewer.viewstation.de/register/>.

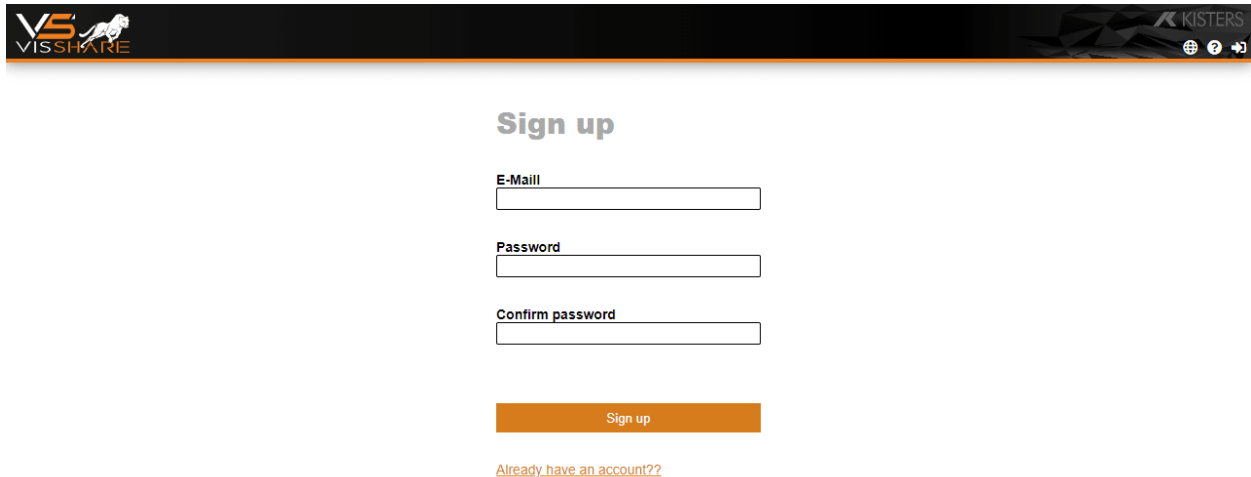

Sign up

E-Mail

Password

Confirm password

Sign up

[Already have an account??](#)

- Enter your e-mail address.
- In the next step, enter your desired password and confirm it using the **CONFIRM PASSWORD** input field.
- Click the **[SIGN UP]** button.
- Enter your contact details in the next step.
- Activate the switch to agree to the privacy policy.

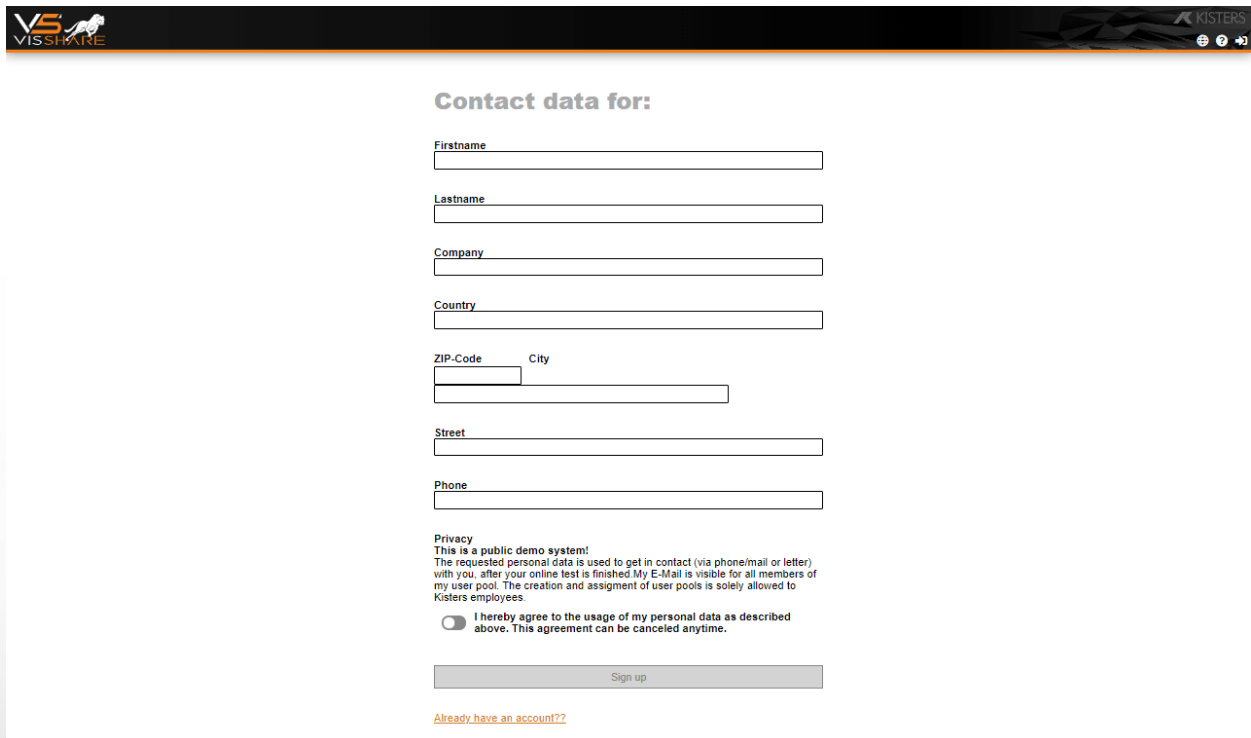

Contact data for:

Firstname

Lastname

Company

Country

ZIP-Code City

Street

Phone

Privacy
 This is a public demo system!
 The requested personal data is used to get in contact (via phone/mail or letter) with you, after your online test is finished. My E-Mail is visible for all members of my user pool. The creation and assignment of user pools is solely allowed to Kisters employees.

I hereby agree to the usage of my personal data as described above. This agreement can be canceled anytime.

Sign up

[Already have an account??](#)

- Finally, click **[SIGN UP]** to complete the registration.

After you have completed the registration process, you will receive an e-mail at the address provided. Follow the instructions in this e-mail. The login to the web portal is described [here](#) .

1.2 Login to VisShare

In order to use VisShare you have to log in to the VisShare web portal.

Note: Registration is only possible after a successful [registration via the web portal](#).

- Open your browser and go to the URL <https://webviewer.viewstation.de/login/>.

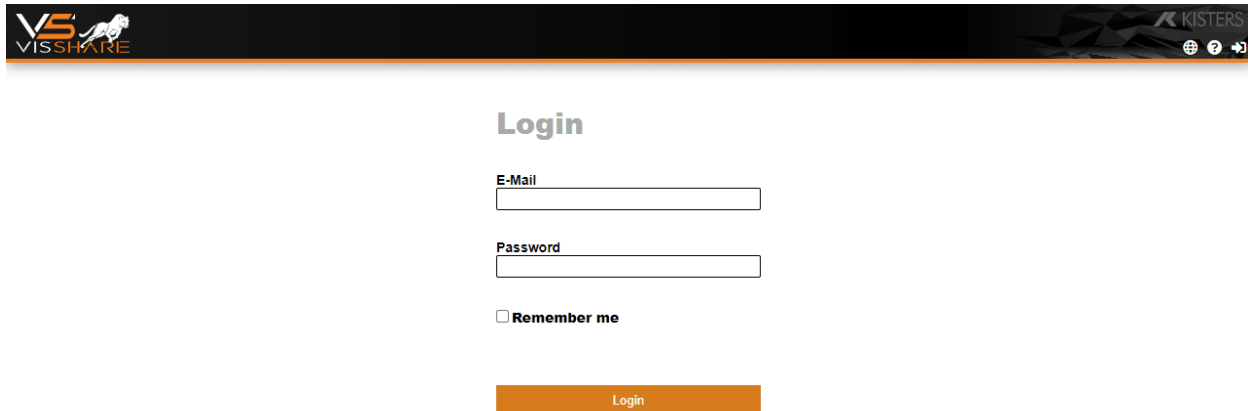

Login

E-Mail

Password

Remember me

Login

- Enter your e-mail address and the corresponding password.
- Click the **[LOGIN]** button.
- The [start page](#) of VisShare is loaded.

1.3 User Interface

In these chapters you will find detailed descriptions of the user interface of VisShare:

- [VisShare Start Page](#)
- [File Manager](#)

1.3.1 VisShare Start Page

After you [have logged in](#), you will be redirected to the start page of VisShare.

The start page is divided into four areas that provide you with all required features.

Click on the area in the graphic to get more information.

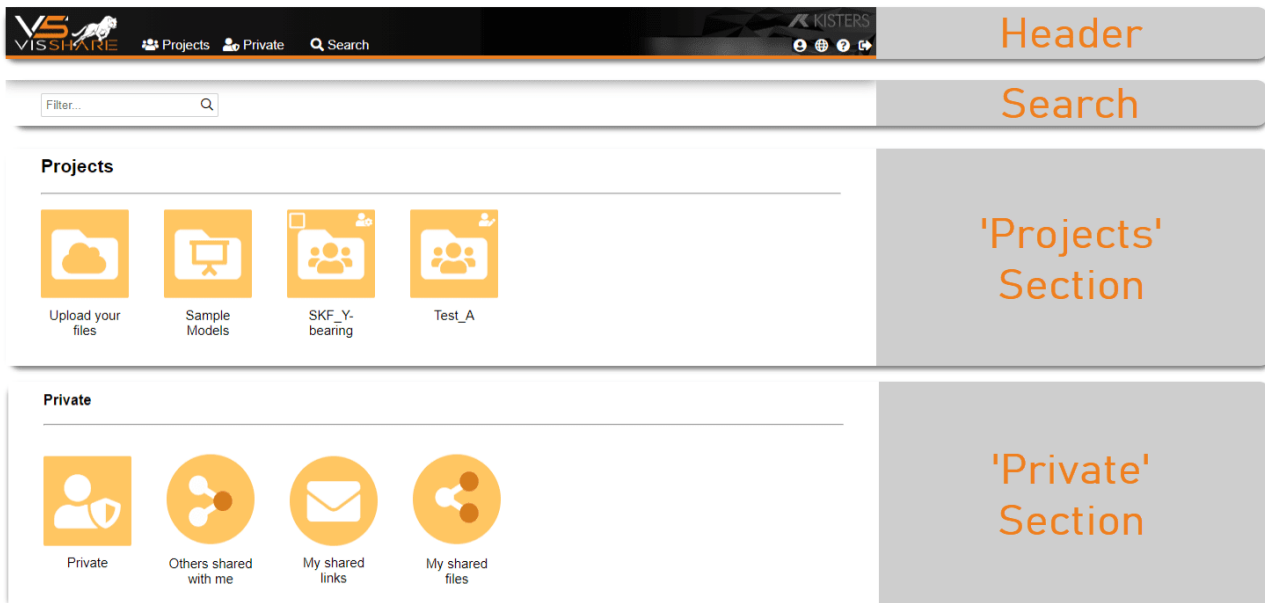

1.3.1.1 Header

In the left-hand area of the header you will find the filter options of VisShare.



You can reduce the number of items displayed on the start page by selecting the filters below. To do this, click on one of the three elements in the header:



- [Projects](#) 
- [Private](#) 
- [Search](#) 



Note: To view the unfiltered start page, click the VisShare logo in the upper left corner.

In the right-hand area of the header you will find various options and settings of VisShare. These are described below.

Options/Settings



 <p>User</p>	<p>The User menu provides you with the following options for interaction:</p> <ul style="list-style-type: none"> ▪ In the CHANGE PASSWORD view, you can change your existing password. ▪ In the FILE LINKS view, all externally shared links are listed in an overview (see My shared links . ▪ By selecting the option CHANGE LAYOUT VisShare is displayed in a version that is optimized for devices with touchscreens. ▪ By selecting the DELETE MY ACCOUNT option, you can delete the current account. Note: When deleting, all personal data will be lost.
 <p>Language</p>	<p>You can change the language of the application at any time.</p> <ul style="list-style-type: none"> ▪ Select a language from the drop-down list.

 Help	Click on the question mark to open the help center of VisShare.
 Logout	To log out of VisShare click on the icon shown on the left.

1.3.1.2 Search

In the **SEARCH** area, you can search for all files that are available to you in VisShare.

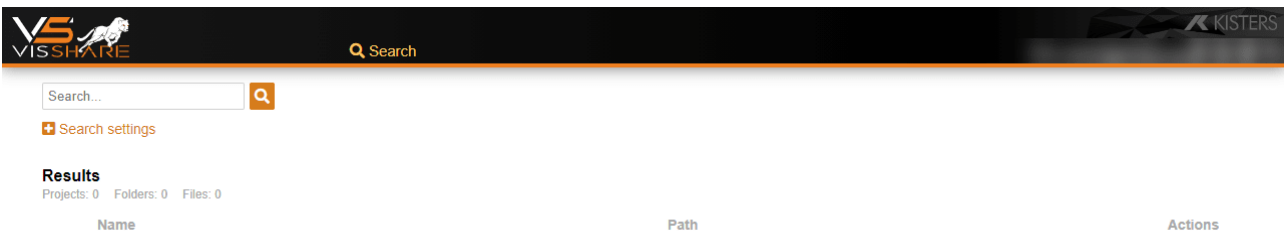

- Click in the **SEARCH...** input field and enter an appropriate search term/file name.
- The search results are displayed in the **RESULTS** section.

Search Settings

In addition to the search term/file name, you can restrict the search with further search settings.

- Click on the **SEARCH SETTINGS** link.

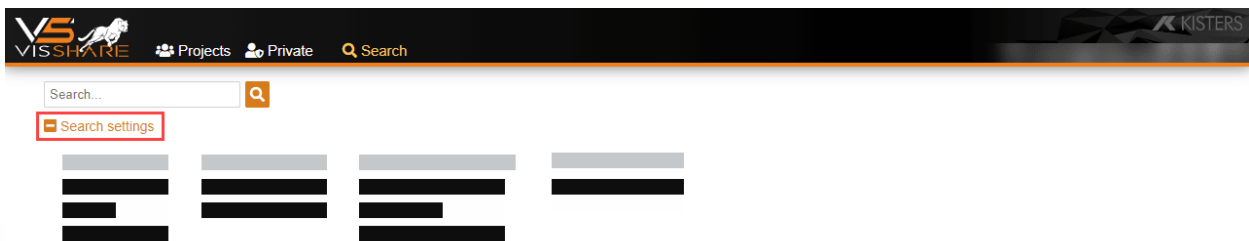

- In the advanced search settings you can activate/deactivate the following attribute filters.
Note: Several attribute filters can be activated at the same time.

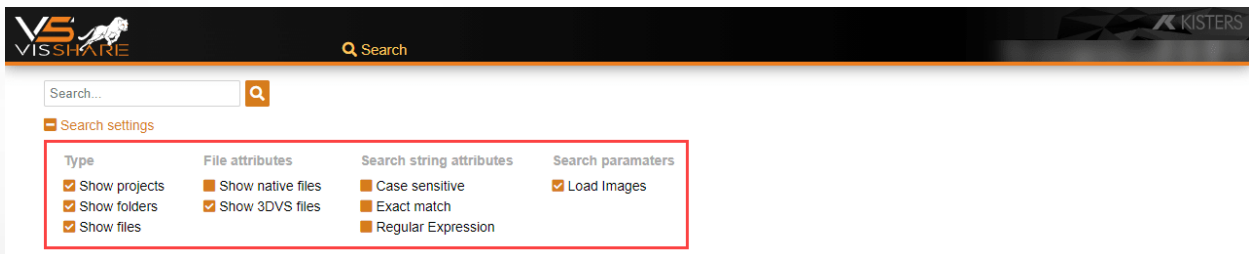

Search options in detail:

Type	
Show projects	Show projects in the search result.

Show folders	Show folders in the search result.
Show files	Show files in the search result.
File attributes	
Show native files	Native files are displayed in the search result. E.g. files in the formats: STP, SLDASM, DWF, IPT.
Show 3DVS files	3DVS files are displayed in the search result.
Search string attributes	
Case-sensitive	The search process is case-sensitive.
Exact match	Only search results that exactly match the search term are displayed.
Regular Expressions	Allows the use of regular expressions (Regular Expression Syntax) to narrow down the search result.
Search parameters	
Loading Images	In the search result, each file is displayed with a thumbnail (only applies to supported formats).

1.3.1.3 Projects

Click on the area in the graphic to get more information.

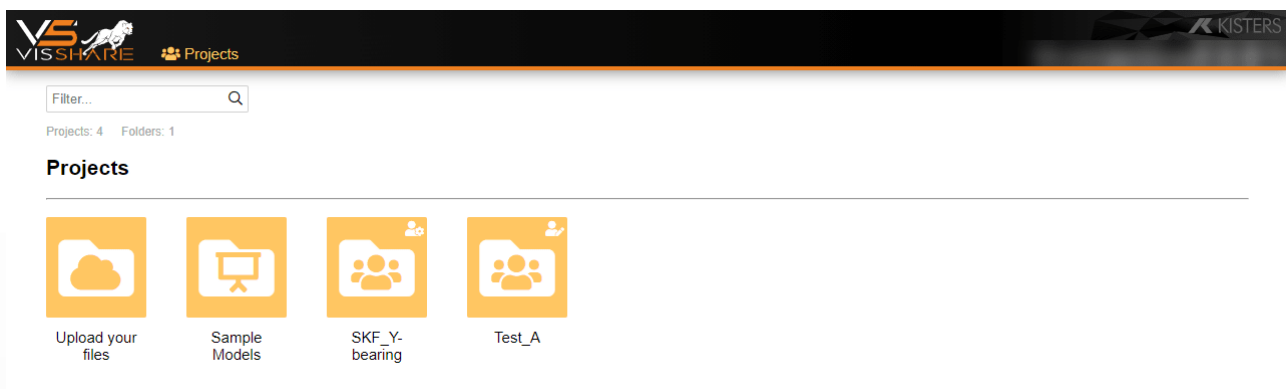

In the **PROJECTS** view, all project-related files and folders are displayed.

Note: Only those files and folders are displayed, for which you have the appropriate access rights.

Further information

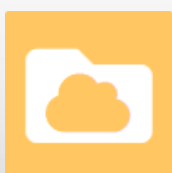

The **UPLOAD YOUR FILES** link takes you to a public folder. Here you have the possibility to upload your own files, which are visible for every user.

Please note: This link may not be displayed as it is for demonstration systems only.



The **SAMPLE MODELS** link takes you to a public folder. Only administrators can upload files to this folder.

Note: This link may not be displayed as it is for demonstration systems only.



Clicking on the link **PROJECT** (individual project name) takes you to the respective projects.

[Here](#) you can find information on creating projects.

Information on uploading files and assemblies can be found [here](#).



Use the link **PROJECT FOLDER** (individual folder name) to access the respective project folders.

Information on creating project folders can be found [here](#).

1.3.1.4 Private

Click on the area in the graphic to get more information.

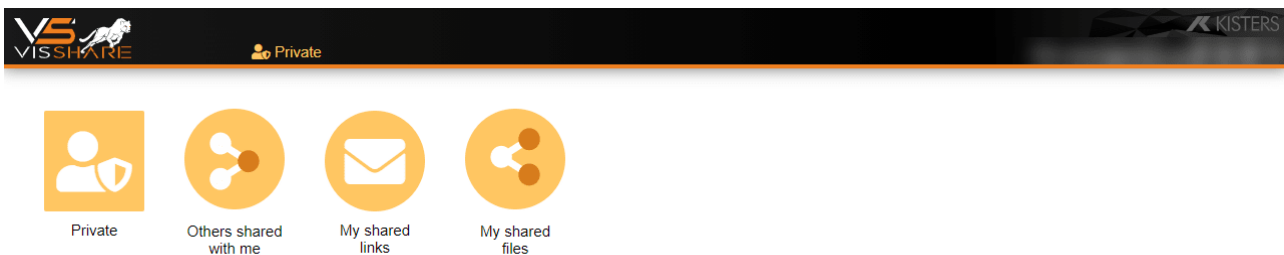

The **PRIVATE** section displays files that are only accessible to you. In addition, you find overviews of shared files.

Further information



The **PRIVATE** link takes you to a view that contains files that are only visible to you. In this private user folder you can upload and manage your files independently of projects.

[Here](#) you can find more information about this view.



The **OTHERS SHARED WITH ME** link takes you to a listing of the files that are shared with you.



The **MY SHARED LINKS** link takes you to a listing of your externally shared files.

[Here](#) you can find more information about this view.



The **MY SHARED FILES** link takes you to a listing of your shared files.

[Here](#) you can find more information about this view.

1.3.2 File Manager

In VisShare projects are displayed in a file manager. The functions of this view are explained in more detail in the following subchapters:

- [Display Options](#)
- [Two-Column File Manager](#)
- [Recycle Bin](#)
- [Context Menu](#)
- [Advanced native loading](#)

You can access this type of view by clicking on one of the square tiles on the VisShare start page.

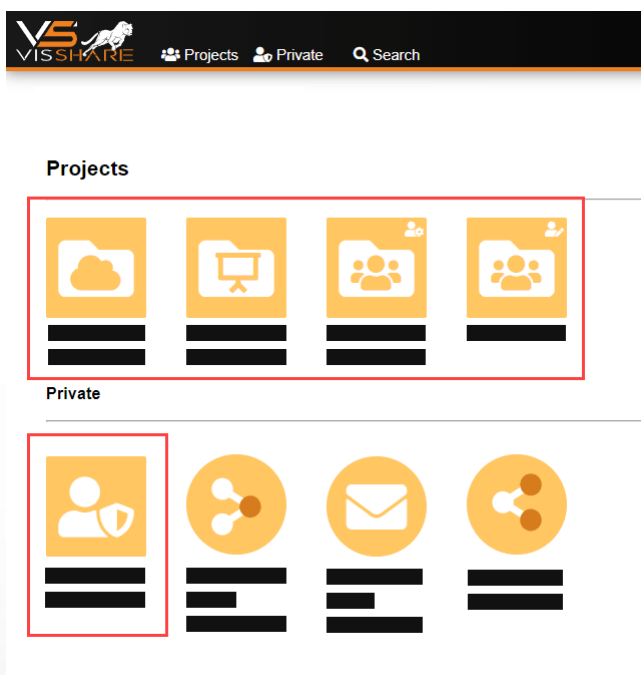

1.3.2.1 Display Options

The file manager in VisShare supports three different display modes.

You can switch between modes using the  icons in the top right corner of the screen.

Grid View

You can display folder contents in a grid view.

- To do this, click the  icon in the upper right corner of the screen.

In this view, the files are displayed in the form of small thumbnails with the corresponding file names.

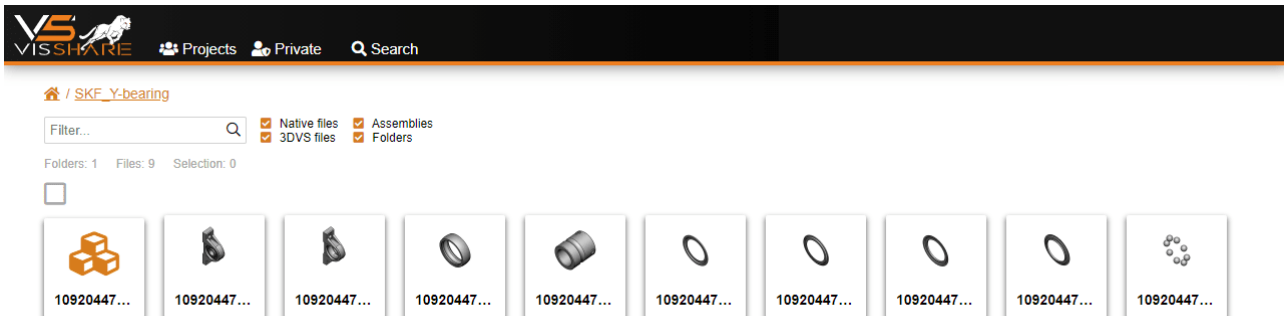

Grid View (large)

You can display folder contents in a magnified grid view.

- To do this, click the  icon in the upper right corner of the screen.

In this view, the files are displayed in the form of thumbnails with the corresponding file names.

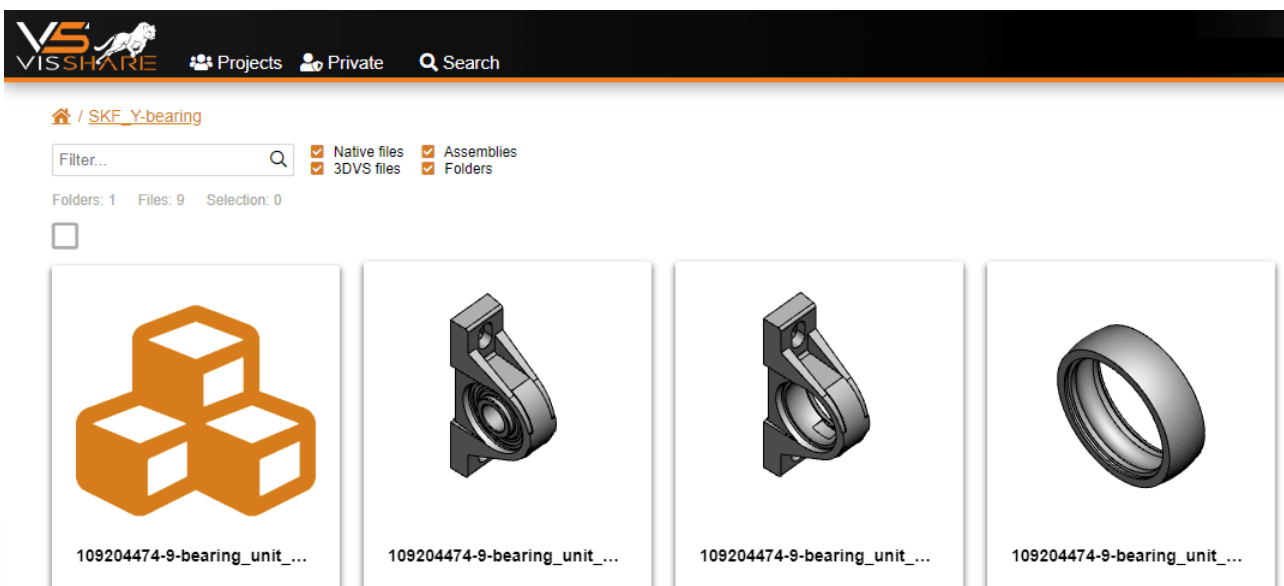



Table View

You can display folder contents in a table view.

- To do this, click the  icon in the upper right corner of the screen.

In this view, the files are displayed in the form of a detailed table.

The table view also offers you the preview function. Cf. chapter [Preview of CAD/CAM Files](#)

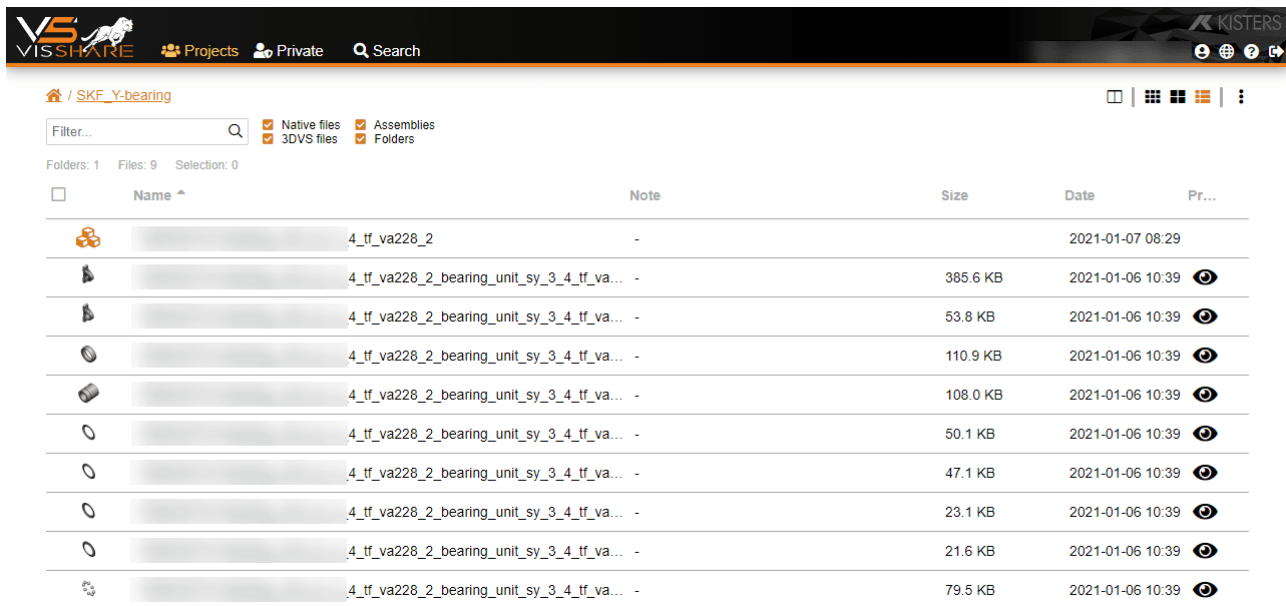

1.3.2.2 Two-Column File Manager

To quickly copy or move files/folders, you can display the VisShare file manager in a two-column view.

- To do this, navigate to the desired source project or source folder.
- Click the icon in the upper right corner of the screen.
 - Note:** In the right column of the file manager, all projects to which you have write access are displayed.
- Select the desired destination in the right column.
- In the left column, select one or more files (folders) that you want to copy or move to the destination.
 - To do this, activate the checkbox of the respective files (folders).
 - Marked files (folders) are highlighted in orange.

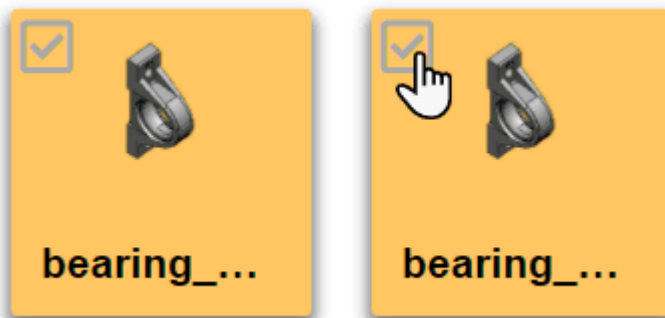

- Click the icon if you want to copy the file (folder).
- Alternatively, click the icon if you want to move the file (folder).
- Click the arrow symbol to copy the file (folder) from the left column to the right column of the file manager.
- Alternatively, click the arrow icon to copy the file (folder) from the right column to the left column of the file manager.

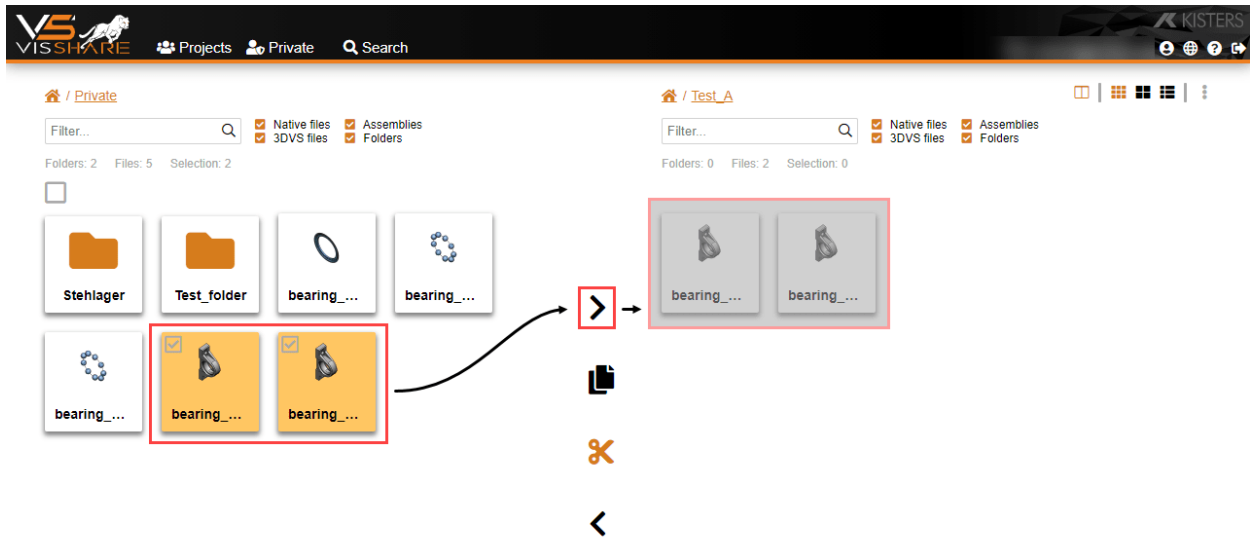



1.3.2.3 Recycle Bin

If you delete files or folders in the file manager of VisShare, they are moved to the recycle bin.

This recycle bin is displayed in the VisShare file manager in the lower right corner of the screen. As soon as an object is in the recycle bin, the number of objects is displayed with a red indicator on the recycle bin.

Restore Deleted Items from the Recycle Bin

You can restore deleted items from the recycle bin. To do this, carry out the following steps:

- Click the  icon in the lower right corner of the screen.
- In the dialog, click the  icon next to the object you want to restore.

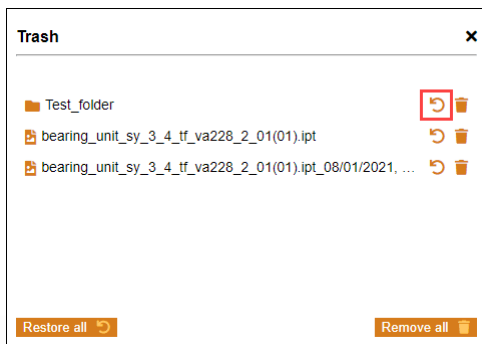



The object is now back at its original storage location.

Note: If you want to restore the entire contents of the recycle bin, click the **[RESTORE ALL]** button.

Delete Objects Permanently

If you want to permanently remove objects from the recycle bin, proceed as follows:

- Click the  icon in the lower right corner of the screen.
- In the dialog, click the  icon behind the object you want to remove permanently.



Note: If you want to delete the entire contents of the recycle bin, click the **[REMOVE ALL]** button.

1.3.2.4 Context Menu

In the file manager of VisShare you have two options to open up the context menu.

- Right-click on a file (folder) or anywhere in the files display area.
- Alternatively, click the  icon in the upper right corner of the screen.

1.3.2.5 Advanced native loading

If you click on a native file (not 3DVS file) in VisShare it will automatically be opened in the 3DViewStation WebViewer. [See tutorial 3DViewStation WebViewer](#)

When you open such a native file, you will be presented with an import dialog. In this dialog you can select a predefined profile. In the future this file will be opened with this setting.

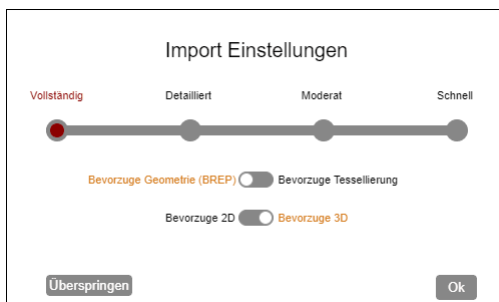

You can disable the display of this dialog.

- To do this, turn off the  **ADVANCED NATIVE LOADING** switch in the lower left corner of the screen.

This option can be used, for example, when you open several files at the same time. Disabling it prevents the loading of models in each tab from being interrupted by this dialog.



Chapter II:

Tutorial



2 Tutorial

This tutorial covers the following topics in detail.

- 'Projects' Section [17](#)
- 'Private' Section [25](#)
- General Interaction with Files and Folders [26](#)
- Interaction with CAD/CAM Files [29](#)
- File Sharing [33](#)

Click on the area in the graphic to get more information.

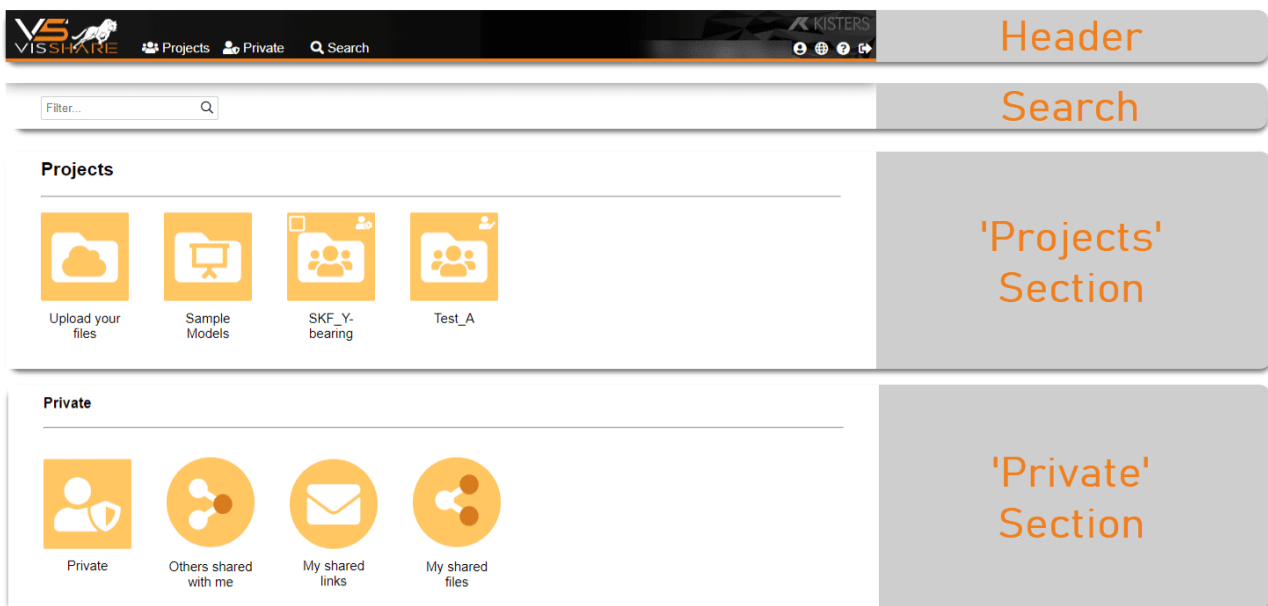

2.1 'Projects' Section

In the following chapters you will find detailed descriptions of the functionality of projects in VisShare:

- Create a Project [17](#)
- Upload File or Assembly [19](#)
- Organize Projects [20](#)
- Manage Projects [21](#)

2.1.1 Create a Project



On the start page of VisShare and in the view 'Projects' you have the possibility to create new projects and to manage them. Within a project you can manage files as described [here](#). [26](#)

A project is identified by the folder icon shown on the left.

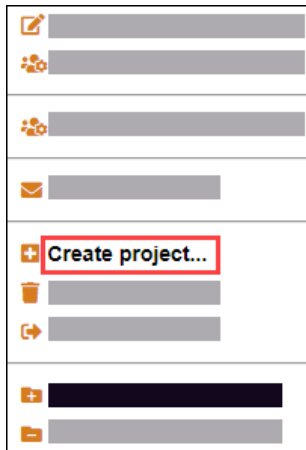

To create a new project, proceed as follows:

- Click on the VisShare logo in the upper left corner to switch to the start page.
- Right-click anywhere on the start page.
- Select **CREATE PROJECT...** from the context menu.



The **CREATE PROJECT** dialog appears.

- Enter a project name in the corresponding text box.
Note: This is a mandatory entry.

- From the **NO ACCESS...** choice list, select the users to whom you want to grant access to this project.
- Click the arrow icon  next to the **READ ONLY MEMBER...** choice list to grant the user read-only permissions.
- Alternatively, click the arrow icon  next to the **MEMBER WITH WRITE ACCESS...** selection field to grant the user read and write permissions.

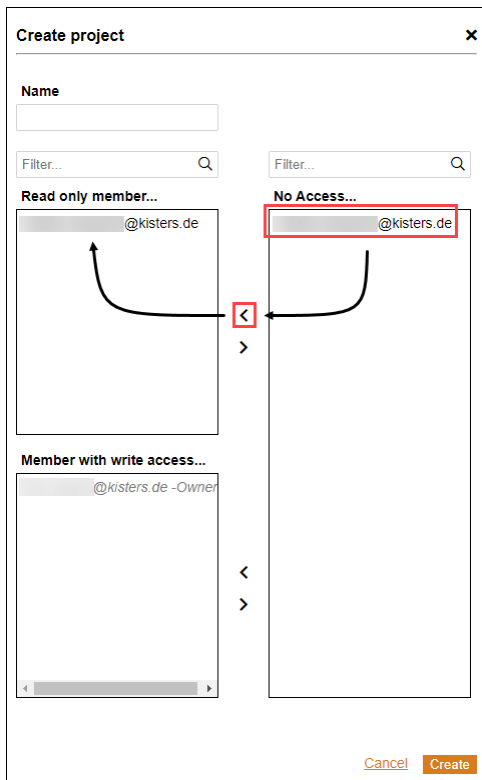

- By activating the **ALLOW DOWNLOAD** switch, you can specify whether users can download the files in this project. By default, this switch is disabled.
- Click the **[CREATE]** button to create the new project.

Note: You can only create a project if you are assigned to a user pool. If necessary, contact your system administrator.

2.1.2 Upload File or Assembly

Follow these steps to upload files or assemblies from your PC to your personal section of VisShare:

- Click on the desired project in the **Projects** section on the start page.

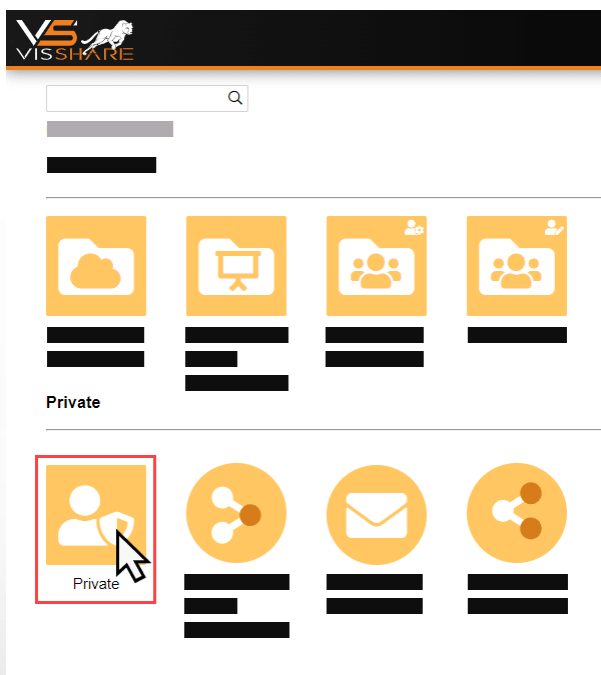

- Click one of the two icons in the lower right corner of the screen to upload either files or assemblies in the selected project.
 -  **UPLOAD FILE**

-  **UPLOAD ASSEMBLY**
- In the dialog, select a file or assembly that you want to upload from your PC.
Note: When uploading assemblies, select the folder in which the assembly is located.
- Click on **[OPEN]**.

Note: After uploading, a copy of the native files is automatically created and converted to 3DVS format. The 3DVS file then appears alongside to the original file.

For more information about interacting with files and assemblies, [click here](#).

2.1.3 Organize Projects

VisShare offers you the possibility to organize your projects in a folder structure. For this purpose, you can manage projects in project folders.



In project folders, you can combine any number of projects into a project group. Project folders contain only projects on the top level - files are located in the respective projects.

A project folder is identified by the folder icon shown on the left.

Create Project Folder

Proceed as follows to create a new project folder:

- Click on the VisShare logo in the upper left corner to switch to the start page.
- Right-click anywhere on the start page.
- Select **CREATE PROJECT FOLDER...** from the context menu.

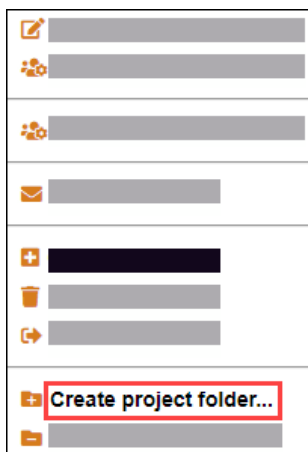

The newly created project folder is displayed in the **PROJECTS** section. Cf. ch. [Projects](#).

In the next step, you can drag and drop any projects into this folder.

Dissolve Project Folder

To dissolve a project folder, proceed as follows:

- Click on the VisShare logo in the upper left corner to switch to the start page.
- Right-click on the desired project folder.
- From the context menu, select **DISSOLVE FOLDER**.

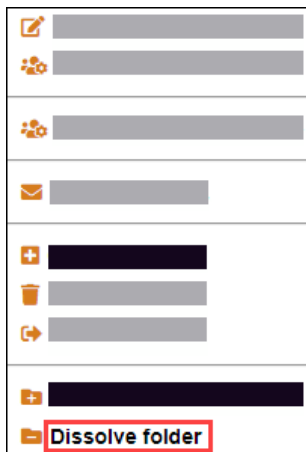



The projects in the selected project folder are moved to the project overview.

Note: No projects are deleted during this process. If you want to delete projects, proceed as described [here](#) ^[24].

2.1.4 Manage Projects

General Information

- Folders marked with the  icon cannot be edited or given administrator rights.
- Folders marked with the  icon can be edited and administrator rights can be granted.

Edit Project

You can subsequently edit the entries and settings you made in the step [Create a Project](#) ^[17].

- To do this, right-click on the project to which you want to make changes.
- Select the **EDIT PROJECT...** entry from the context menu.



- You can now make the desired changes in the dialog that appears.

Manage Project Administrators

As a project owner or as an administrator, you can define which users from the user pool are granted administrator rights to a project.

Note: When you create a new project, you automatically become the project owner. Cf. chapter [Creating a Project](#)

- To do this, right-click on the project to which you want to make the change.
- Select the **MANAGE ADMINISTRATORS...** entry from the context menu.
- In the dialog, select the desired user from the **NON-ADMINISTRATOR...** column.
- Click the arrow icon  to move this user to the **ADMINISTRATOR...** column.

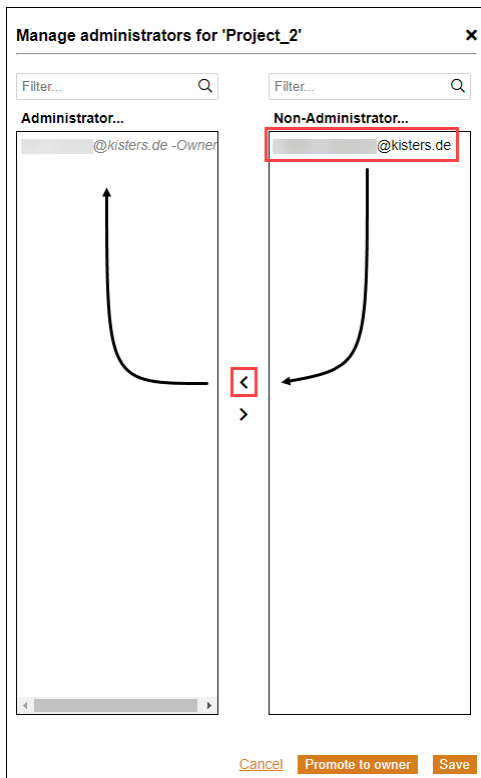

- Click the **[SAVE]** button to complete the operation.

Promote User to Project Owner

Users who are in the **ADMINISTRATOR...** column can be promoted to project owners.

- In the **MANAGE ADMINISTRATORS FOR 'PROJECT NAME'** dialog, select the desired user from the **ADMINISTRATOR...** column.

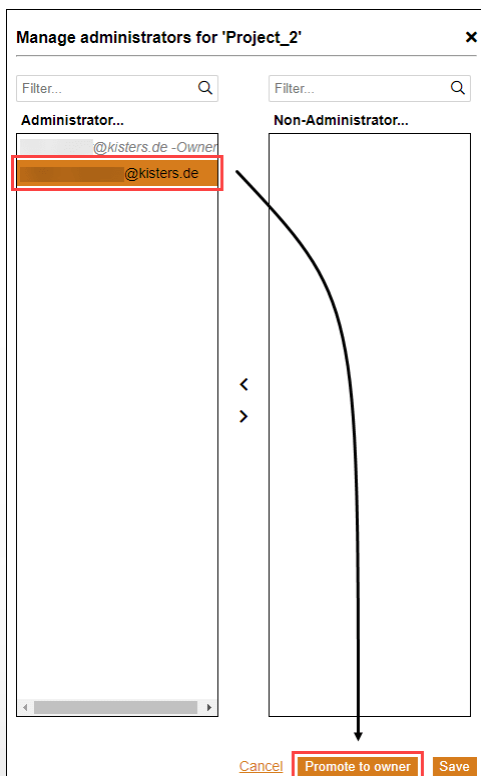

- Click the **[PROMOTE TO OWNER]** button.

Note: If you promote a user to the owner of a project, you lose your administrator rights over that project.

Set Project Type

VisShare offers you the possibility to assign your projects to certain project types.

- To do this, right-click on the desired project.
- Select the **PROJECT TYPE...** entry from the context menu.

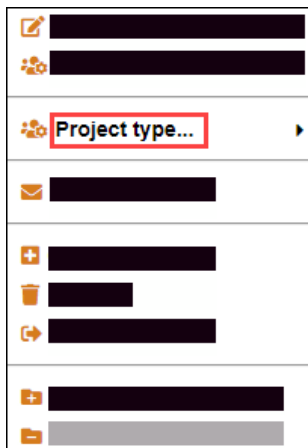

- Select one of the project types from the submenu.

Project type	Description
Public	Any verified user can view this project and upload files there. Guests have read-only access to this project.
Showcase	Any verified user can view this project. Only users with the appropriate permission are allowed to upload files.
Restricted (default setting)	Users can only view this project (and upload files) if they have been explicitly given access to this project. Cf. chapter Creating a Project

Invite Users to a Project via E-Mail

VisShare offers you the possibility to invite registered users to an existing project via e-mail.

- To do this, right-click on the project to which you want to invite a user.
- Select **INVITE VIA E-MAIL...** from the context menu.

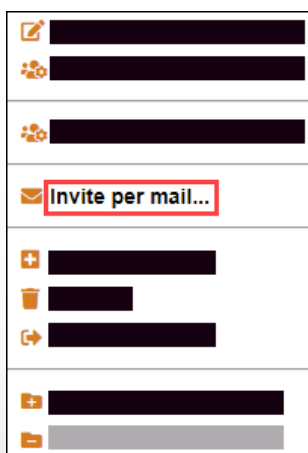

- Enter the e-mail address of the new user in the dialog. You can invite several users to an existing project at the same time. Separate the e-mail addresses with a comma.



- By activating the **WRITE ACCESS** switch, you can grant the invited user write access in this project.
- Click the **[OK]** button to complete the operation. The added user will receive a corresponding e-mail from the sender `visshare@kisters.de` shortly afterwards.

Note: To use the mentioned functionality, you must either be the **owner of the project** or have **administrator rights**.

Delete Project

You can delete existing projects.

- To do this, right-click on the project that you want to delete.
- Select **DELETE PROJECT** from the context menu.

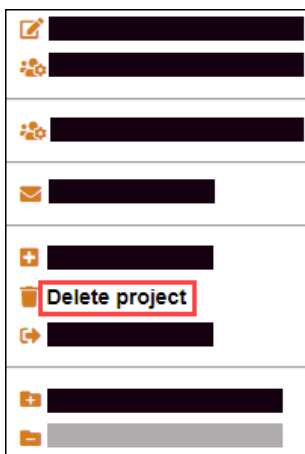

- Click the **[DELETE]** button in the dialog.

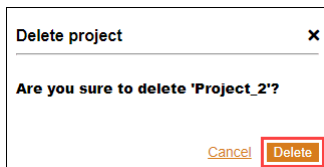

Note: To use the mentioned functionality, you must either be the **owner of the project** or have **administrator rights**.

Leave a Project

You can leave projects in which you no longer wish to participate.

Note: If you select Leave in the context menu, you leave the project without further confirmation.

- To do this, right-click on the project that you want to leave.
- Select **LEAVE** from the context menu.

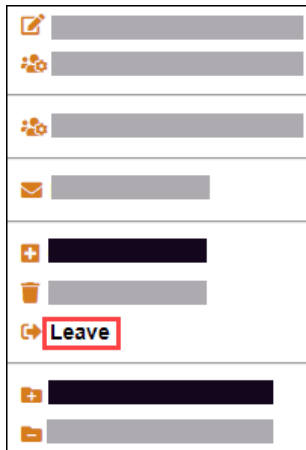

Note: Project owners cannot leave their own project. It is not possible to leave the project until you have promoted another user to be the owner of this project. Cf. [Promote User to Project Owner](#)

2.2 'Private' Section

In the 'Private' section, you can store your files independently of projects. Only you have access to these files.

In the following chapters, the 'Private' section is described in detail:

- [Create a Folder](#)
- [Upload File or Assembly](#)

2.2.1 Create a Folder

Follow the steps below to create a folder in your personal section of VisShare:

- On the start page, click the **Private** link in the section **PRIVATE**.

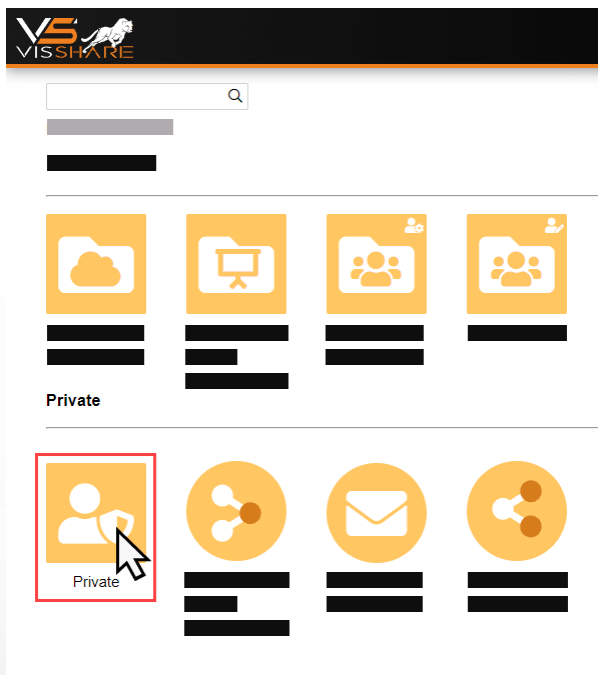

- Click the **CREATE FOLDER** icon in the lower right corner of the screen.
- Enter a name for the new folder in the following dialog.

- Click on [OK].

Note: You can also create folders in existing folders and thus nest them.

For more information on how to interact with folders, [click here](#).

2.2.2 Upload File or Assembly

Follow these steps to upload files or assemblies from your PC to your personal section of VisShare:

- On the start page, click the **Private** link in the section **PRIVATE**.

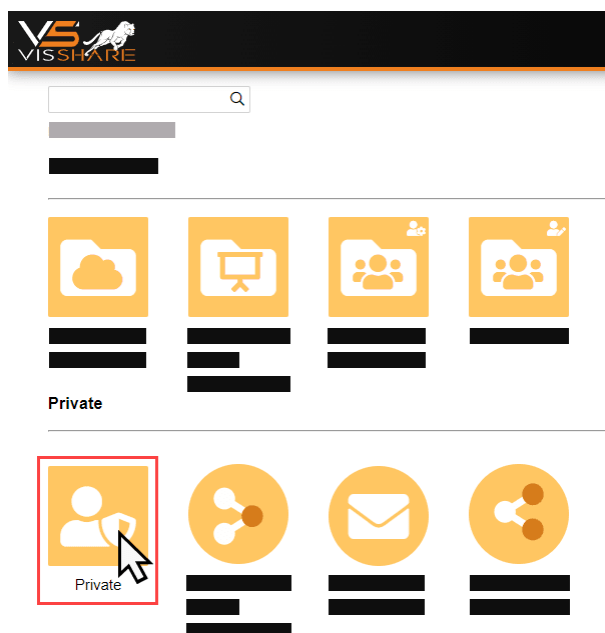

- Click on one of the two icons in the lower right corner of the screen to upload either files or assemblies to your personal space.
 - **UPLOAD FILE**
 - **UPLOAD ASSEMBLY**
- In the dialog, select a file or assembly that you want to upload from your PC.
 - Note:** When uploading assemblies, select the folder in which the assembly is located.
- Click on [OPEN].

Note: After uploading, a copy of the native files is automatically created and converted to 3DVS format. The 3DVS file then appears alongside to the original file.

For more information about interacting with files and assemblies, [click here](#).

2.3 General Interaction with Files and Folders

If you are in the directory structure of VisShare you can perform all common actions that you know from the Microsoft Windows file manager.

You can access the directory structure by clicking on one of the square tiles on the VisShare start page.

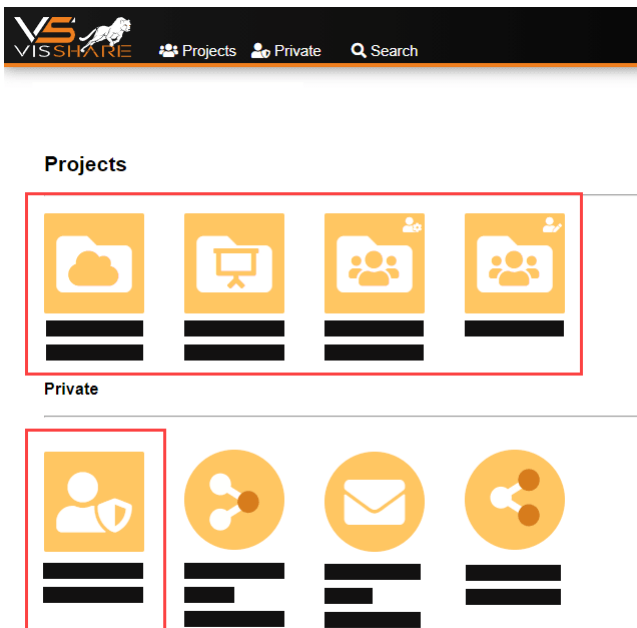

Copy, Delete, Paste, Cut, Rename

Right-click on a file/assembly or folder in the directory structure. The context menu displays the possible options for interaction.

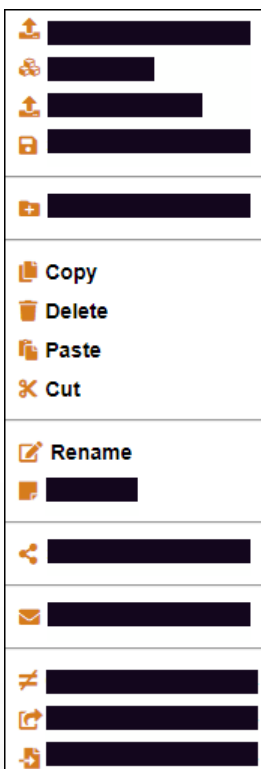

In addition to this context menu, VisShare also offers a two-column file manager. Use this feature to avoid time-consuming navigation between folders. Cf. chapter [Two-column file manager](#) ^[13]

Note

You can add individual notes to files in the directory structure.

- Right-click on the desired file.
- Select **NOTE** on the context menu.

Key combination	Action
CTRL + A	Select all elements in the current view.

2.4 Interaction with CAD/CAM Files

In these chapters you will find detailed descriptions of the individual functions:





- [Preview of CAD/CAM Files](#) ²⁹
- [Save File in 3DVS Format](#) ²⁹
- [Compare two 3D Models with Each Other](#) ³⁰
- [Open File in Scene](#) ³¹
- [Import File into Scene](#) ³²

2.4.1 Preview of CAD/CAM Files

If you have activated the [table view](#) ¹² display format in the VisShare file manager, an interactive preview is available for compatible CAD/CAM files.

- To activate the preview, click the  icon next to the file you want to preview.

The preview is displayed in the right pane of the file manager. You can move, rotate and scale the model in the preview view.

<input type="checkbox"/>	Name ^	Note	Size	Date	P...
	bearing_unit_sy_3_4_tf_va228_2_0...	-	177.0...	2019-...	
	bearing_unit_sy_3_4_tf_va228_2_0...	-	53.8 KB	2021-...	

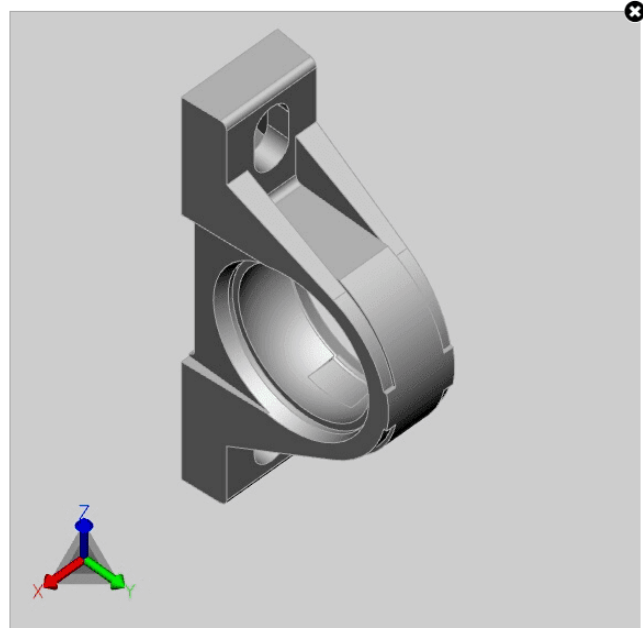

2.4.2 Save File in 3DVS Format

VisShare offers you the possibility to save native files in the 3DVS format.

- Right-click on the desired file.
- Select **SAVE AS 3DVS** from the context menu.



The new file is stored in the directory of the original file. In addition to the `.3dvs` file extension, the file name of the new file contains the current date and time.

<input type="checkbox"/>	Name ^	Note	Size	Date	Pr...
<input type="checkbox"/>	bearing_unit_sy_3_4_tf_va228_2_01(01).ipt	-	177.0 KB	2019-08-08 08:11	
<input type="checkbox"/>	bearing_unit_sy_3_4_tf_va228_2_01(01).ipt_08/01/2021, 14:00.3dvs	-	53.8 KB	2021-01-08 14:00	

2.4.3 Compare two 3D Models with Each Other

VisShare gives you quick access to the analysis method for comparing two 3D models.

- To do this, select the two files (3D models) that you want to compare.
- Right-click on one of the files to be compared.
- Select **COMPARE TWO 3D FILES** from the context menu.



The comparison of the two 3D models will open in a new tab in your browser.

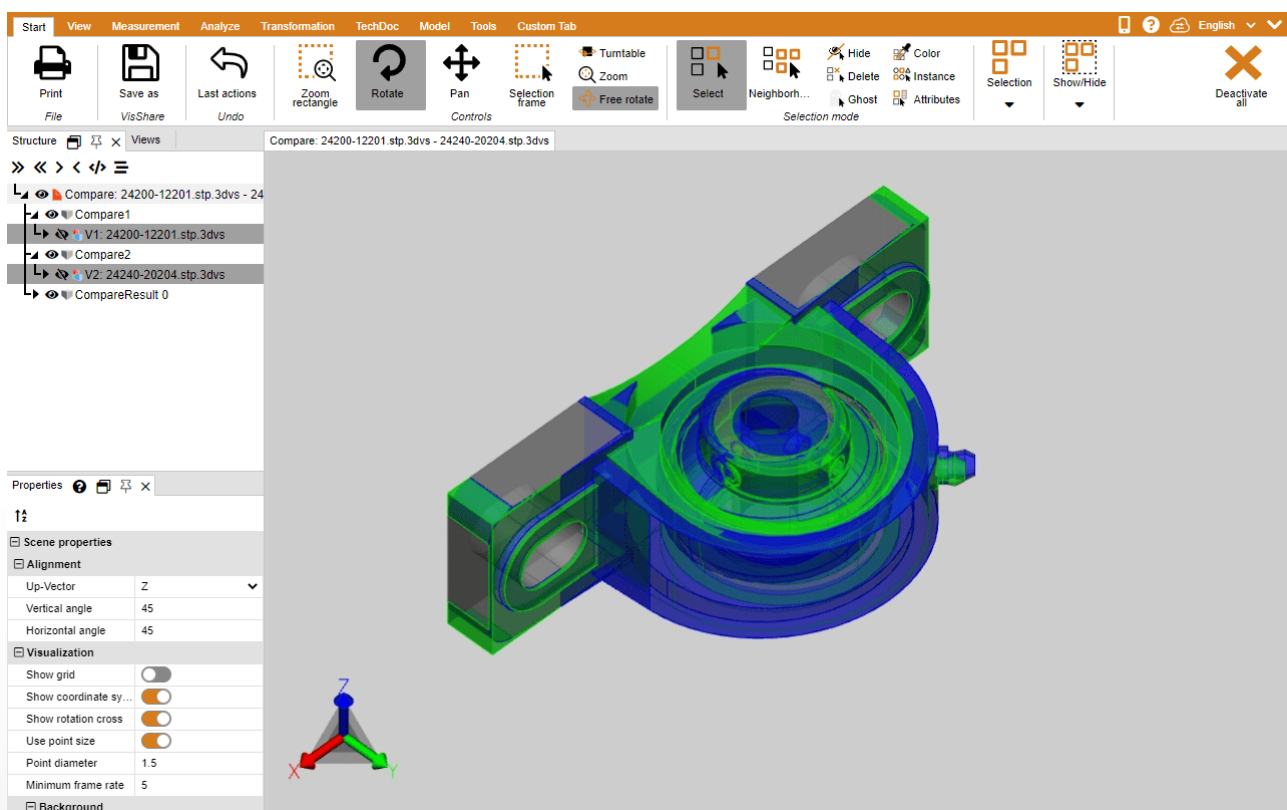

2.4.4 Open File in Scene

When you open a model in VisShare this model is always open in a new tab (scene) in your browser. The **Open in scene** option allows you to open a model in an existing tab (scene). This slightly reduces the loading time.

- To do this, right-click on the file you want to open.
- Select **OPEN IN SCENE** from the context menu.

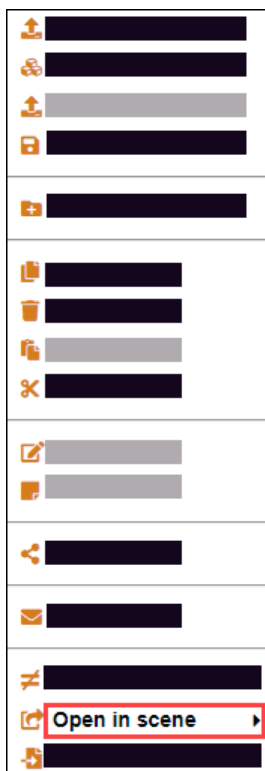

- From the sub menu, select the scene in which you want to open the file.
Note: The file already open in the selected scene is closed during this process.

2.4.5 Import File into Scene

VisShare offers you the possibility to open two models in one scene.

- To do this, right-click on the file you want to open in an existing scene.
- Select **IMPORT TO SCENE** from the context menu.

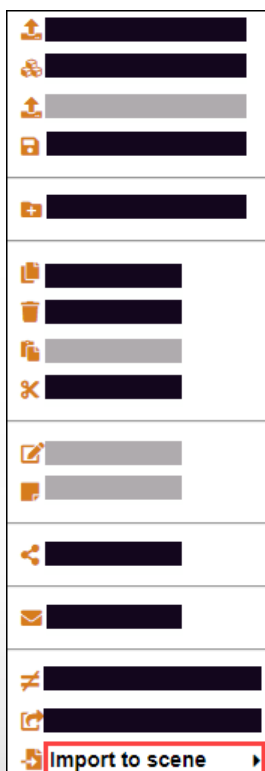

- From the sub menu, select the scene to which you want to add the model.
Note: The models are usually displayed superimposed.

2.5 File Sharing

VisShare offers you the possibility to share files with other people independently of projects.

In this chapter you will find detailed descriptions of this functionality:

- [Share Files with Users](#) ^[33]
- [Share Files via a Link](#) ^[34]

2.5.1 Share Files with Users

Files that are located in project folders or in your private user folder can be shared with other VisShare users.

The requirements for sharing files are:

- The VisShare user with whom you want to share the file is in your user pool.
- The project must have the project type **Restricted** assigned.
Note: The project type **Restricted** is the default setting when creating a new project.

Share a File with a VisShare User

To share a file with another VisShare user, proceed as follows:

- Right-click on the desired file.
- Select **SHARE FILE...** from the context menu.

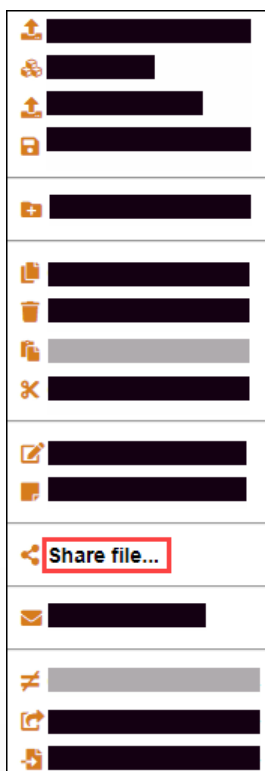

- In the dialog in the right-hand column, select the user with whom you want to share the file.
- Click the arrow icon  to move the selected user to the left column.

Send or copy links ✕

Links

bearing_unit_sy_3_4_tf_va228_2_01(01).ipt_08/01/2021, 14:00.3dvs:
<https://visshare.kisters.de/file-link/66ae5c1828e50f6df940e76848d89762>

E-Mails

Valid from

Valid until

Limit access to

Send automated mails

[Open links in Mail Client...](#)

[Cancel](#) [Create](#)

- Alternatively, click the **OPEN LINKS IN MAIL CLIENT...** link to send the link using your default mail client.
 - Alternatively, click the **[CREATE]** button if you want to use the link later in another application.
- Note:** You can view and manage generated links in the **PRIVATE** section via the **MY SHARED LINKS** link. Cf. subchapter [Managing File Links](#)

Manage File Links

You can manage links to files in the **FILE LINKS** view.

- Click on the VisShare logo in the upper left corner to switch to the start page.
- In the **PRIVATE** section, click the **MY SHARED LINKS** link.
- In the **ACTIONS** column, click the icon to edit the link to the corresponding file.
- If you want to delete a link to a file, click the icon .

Note: The link will be removed without further confirmation.

Projects Private Search
KISTERS

File links

Filter...

File links: 4

<input type="checkbox"/>	Filename	Note	E-Mail	From	Until	View count	Limit	ID	Actions
<input type="checkbox"/>	..._3_4_tf_va22...	-		-	-	0	∞	215	
<input type="checkbox"/>	..._3_4_tf_va22...	-		-	-	0	∞	214	
<input type="checkbox"/>	..._3_4_tf_va22...	-		-	-	0	∞	213	
<input type="checkbox"/>	..._3_4_tf_va22...	-		-	-	2	∞	162	